



About Science Prof Online PowerPoint Resources

- Science Prof Online (SPO) is a free science education website that provides fully-developed Virtual Science Classrooms, science-related PowerPoints, articles and images. The site is designed to be a helpful resource for students, educators, and anyone interested in learning about science.
- The SPO Virtual Classrooms offer many educational resources, including practice test questions, review questions, lecture PowerPoints, video tutorials, sample assignments and course syllabi. New materials are continually being developed, so check back frequently, or follow us on Facebook (Science Prof Online) or Twitter (ScienceProfSPO) for updates.
- Many SPO PowerPoints are available in a variety of formats, such as fully editable PowerPoint files, as well as uneditable versions in smaller file sizes, such as PowerPoint Shows and Portable Document Format (.pdf), for ease of printing.
- Images used on this resource, and on the SPO website are, wherever possible, credited and linked to their source. Any words underlined and appearing in blue are links that can be clicked on for more information. PowerPoints must be viewed in *slide show mode* to use the hyperlinks directly.
- Several helpful links to fun and interactive learning tools are included throughout the PPT and on the Smart Links slide, near the end of each presentation. You must be in *slide show mode* to utilize hyperlinks and animations.
- This digital resource is licensed under Creative Commons Attribution-ShareAlike 3.0 : <http://creativecommons.org/licenses/by-sa/3.0/>

Alicia Cepaitis, MS
Chief Creative Nerd
Science Prof Online
Online Education Resources, LLC
alicia@scienceprofonline.com

Tami Port, MS
Creator of Science Prof Online
Chief Executive Nerd
Science Prof Online
Online Education Resources, LLC
info@scienceprofonline.com

Metabolism

Catabolism of Proteins & Fats



Catabolism of Proteins & Fats

Q: So far in our study of metabolism, what has provided the energy used to make ATP?



Catabolism of Proteins & Fats

- How do we metabolize things that aren't glucose?
- [Fats](#), [proteins](#) and [carbs](#) can all provide energy for the cell.
- Basic pathways used to extract energy from fat & protein are the same as for carbs: glycolysis, Krebs, [ETC](#) but there are some extra steps.



Organic Molecules - Proteins

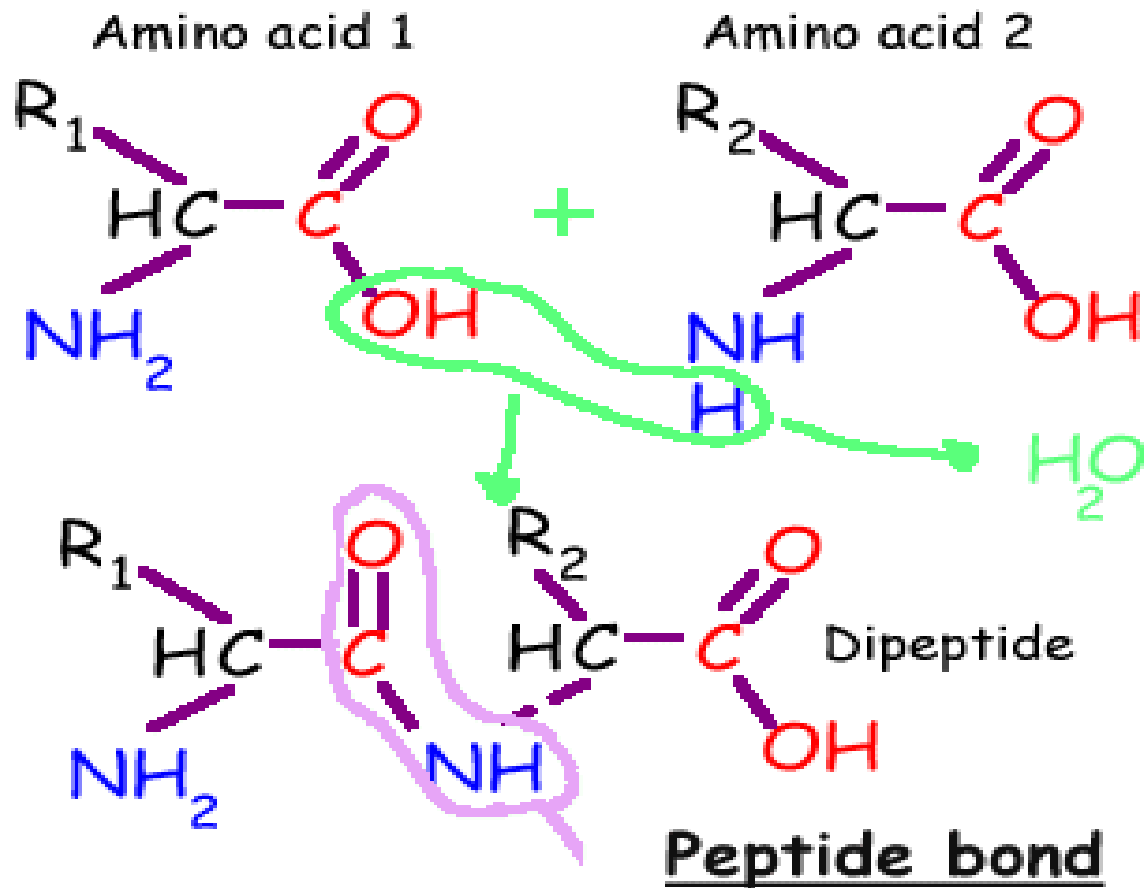

Dehydration synthesis is the chemical reaction that joins amino acids into polypeptide.

Q: What reaction breaks down polypeptides into amino acids?

Protein Catabolism

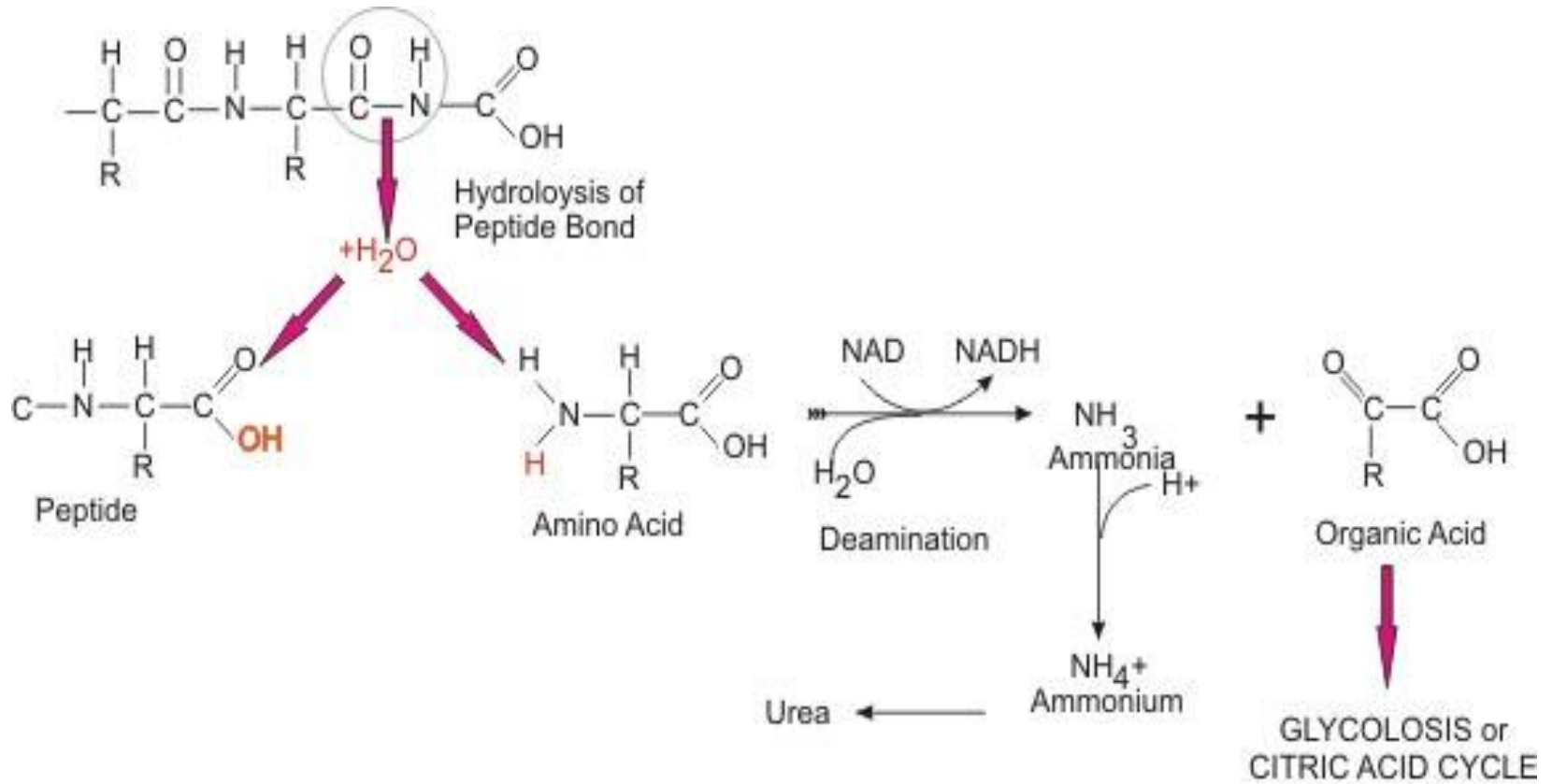

PROTEIN CATABOLISM

Frank Boumphrey M.D. 2009

How do we metabolize protein?

Excess amino acids can be used to synthesize pyruvate, acetyl CoA, and ketogluterate, which enters the Krebs cycle.

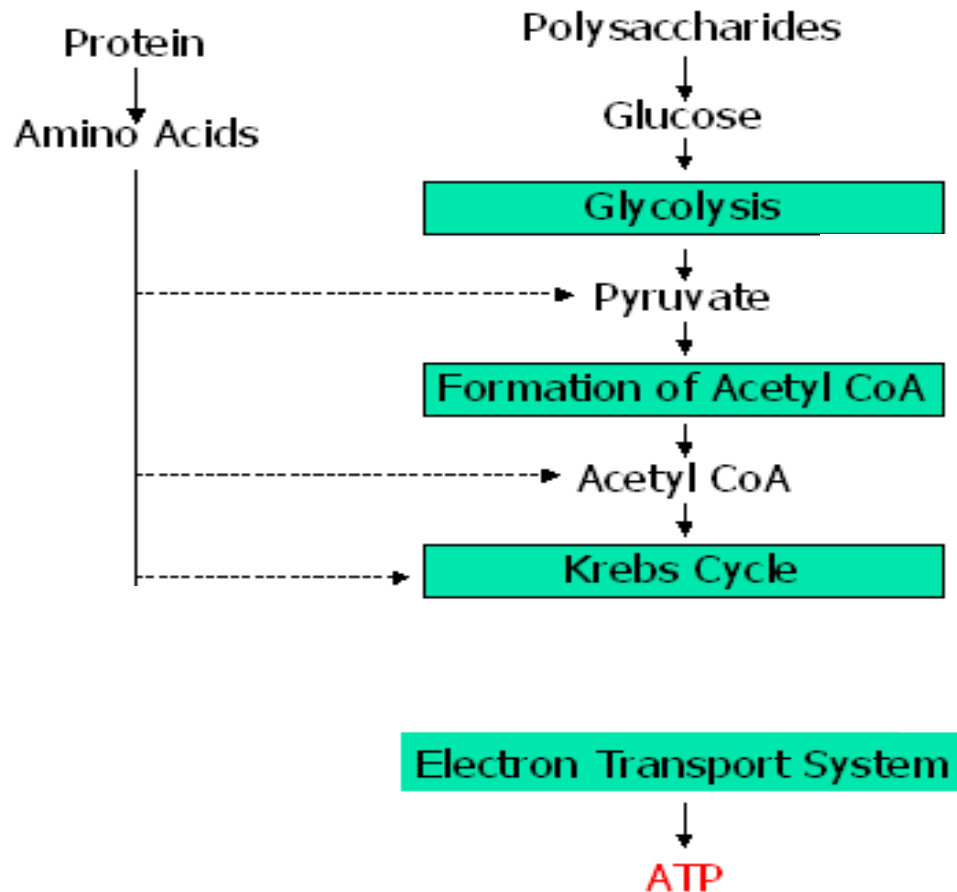

How do we metabolize protein?

Excess amino acids can be used to synthesize pyruvate, acetyl CoA, and ketogluterate, which enters the Krebs cycle.

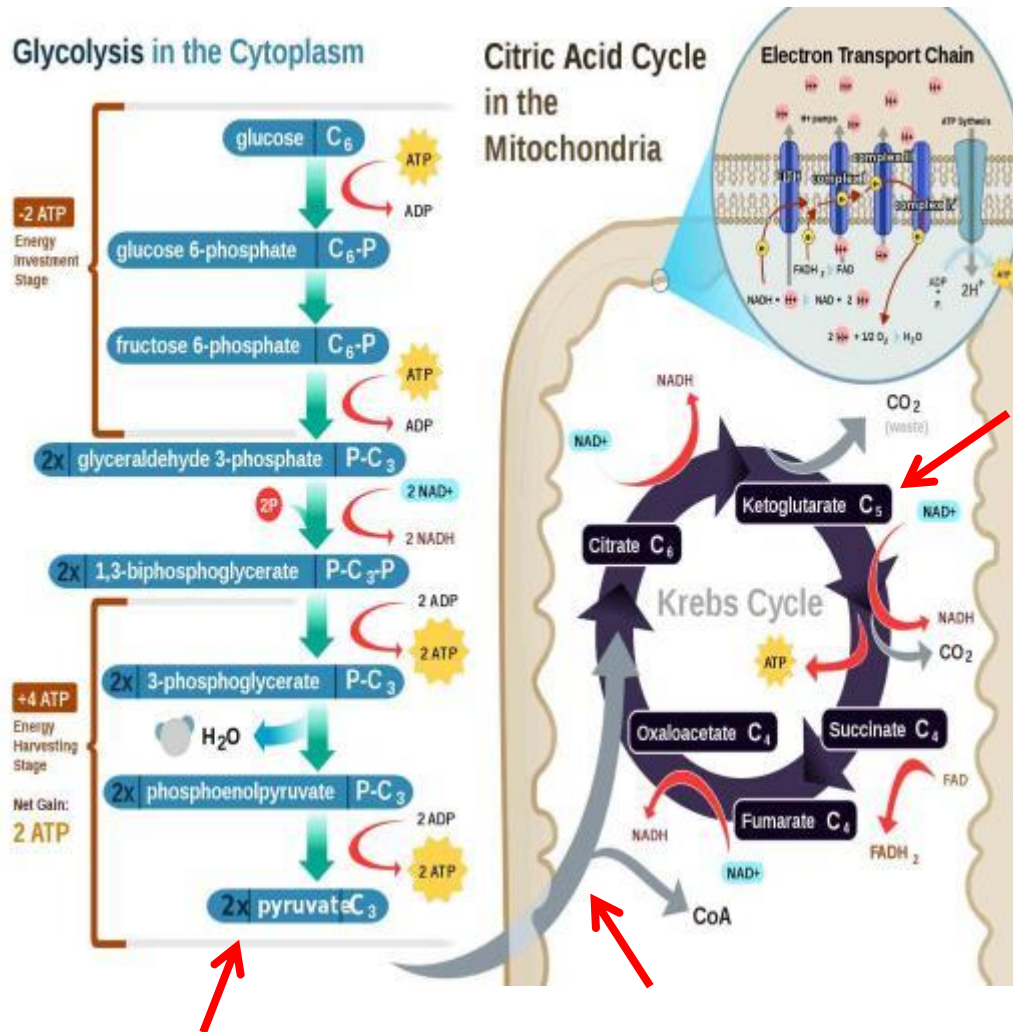

REVIEW!

Animated lesson on Protein Catabolism

How do we metabolize fats?

- **Q:** Fats and oils are made from which two kinds of molecules?
- Before these fats can be broken down to release energy, they must be converted to smaller units.
- The first step is to break the bonds between the glycerol and the fatty acids.

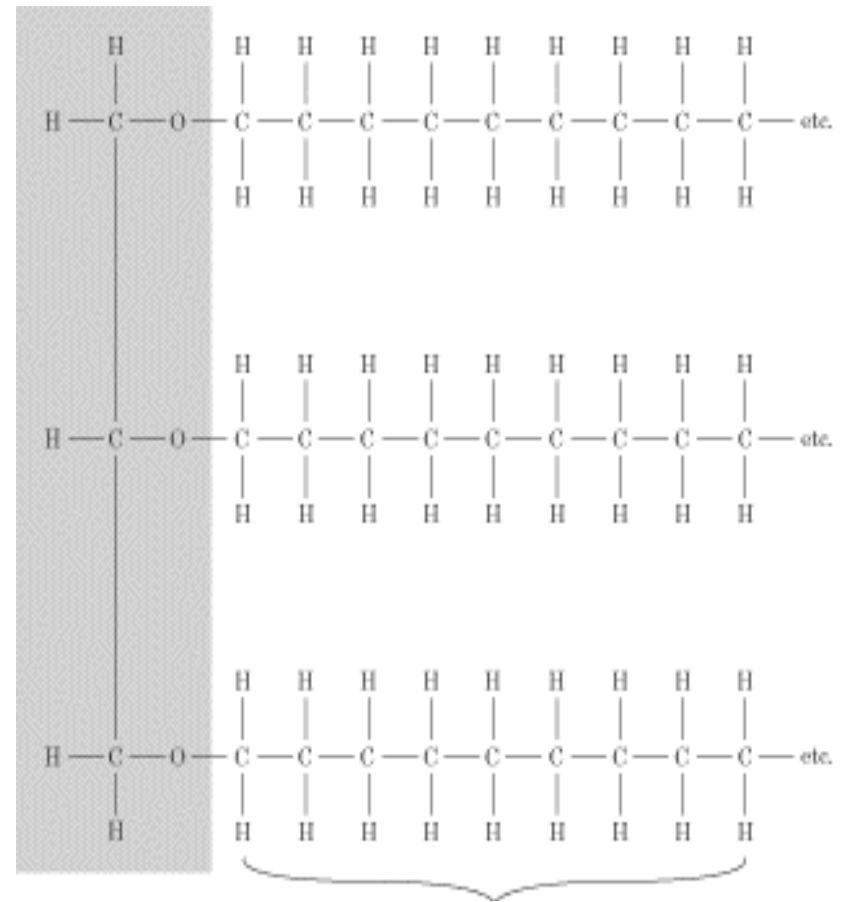

How do we metabolize fats?

- Glycerol is a 3-carbon molecule that is converted into **glyceraldehyde-3-phosphate**.
- Because glyceraldehyde-3-phosphate is **involved in one of the steps in glycolysis**, it can enter the glycolysis pathway.

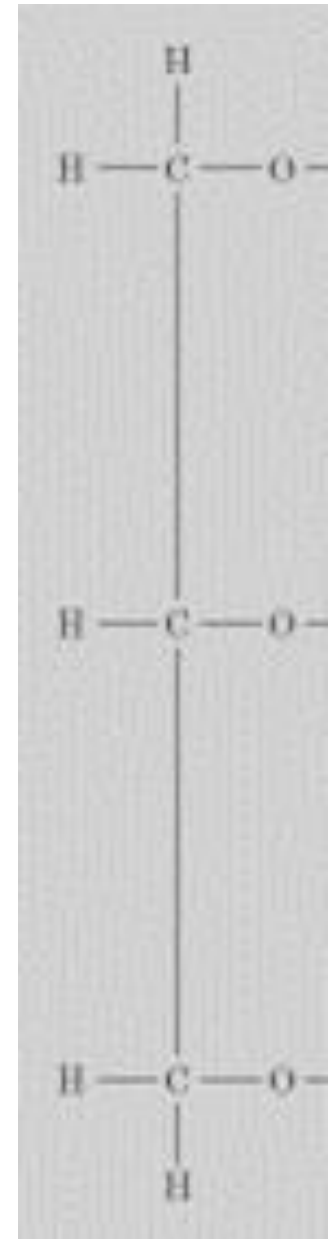

How do we metabolize fats?

Glycolysis in the Cytoplasm

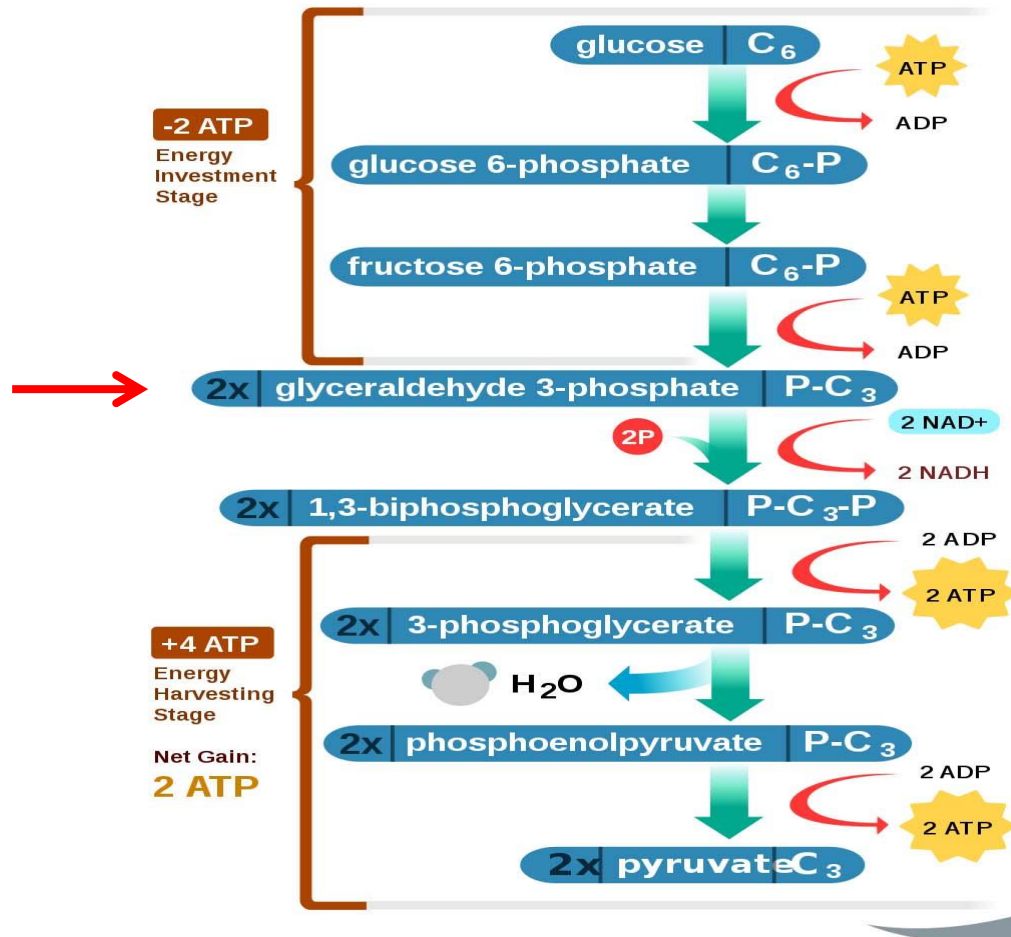

How do we metabolize fatty acid tails?

These long molecules (typically 14 to 20 carbons long) must also be processed before they can be further metabolized.

1. Enter the mitochondrion, where each long chain of carbons that makes up the carbon skeleton is hydrolyzed (split by the addition of a water molecule) into 2-carbon fragments.

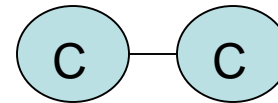

2. Each of the 2-carbon fragments is converted into acetyl. Coenzyme A is added to the acetyl, and the _____ goes into _____.

Figure J-7: Fatty Acid Metabolism

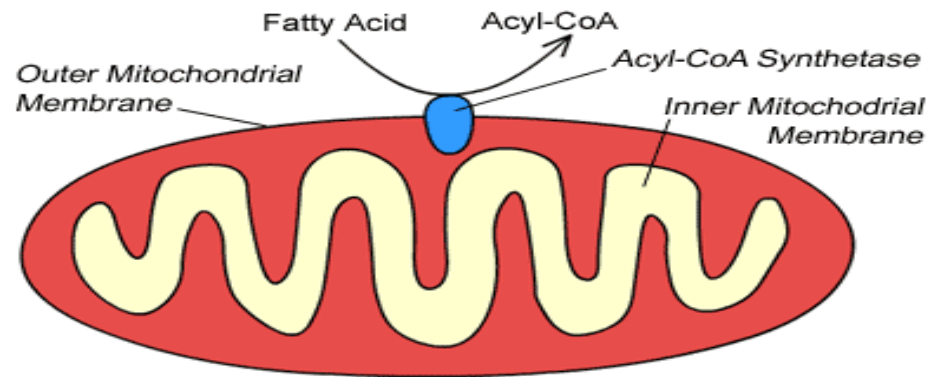

The Acyl-CoA Synthetase enzyme activates the fatty acid and transforms it to Acyl-CoA.

How do we metabolize fatty acid tails?

Krebs Cycle

(a.k.a Citric Acid Cycle)

Acetyl-CoA →

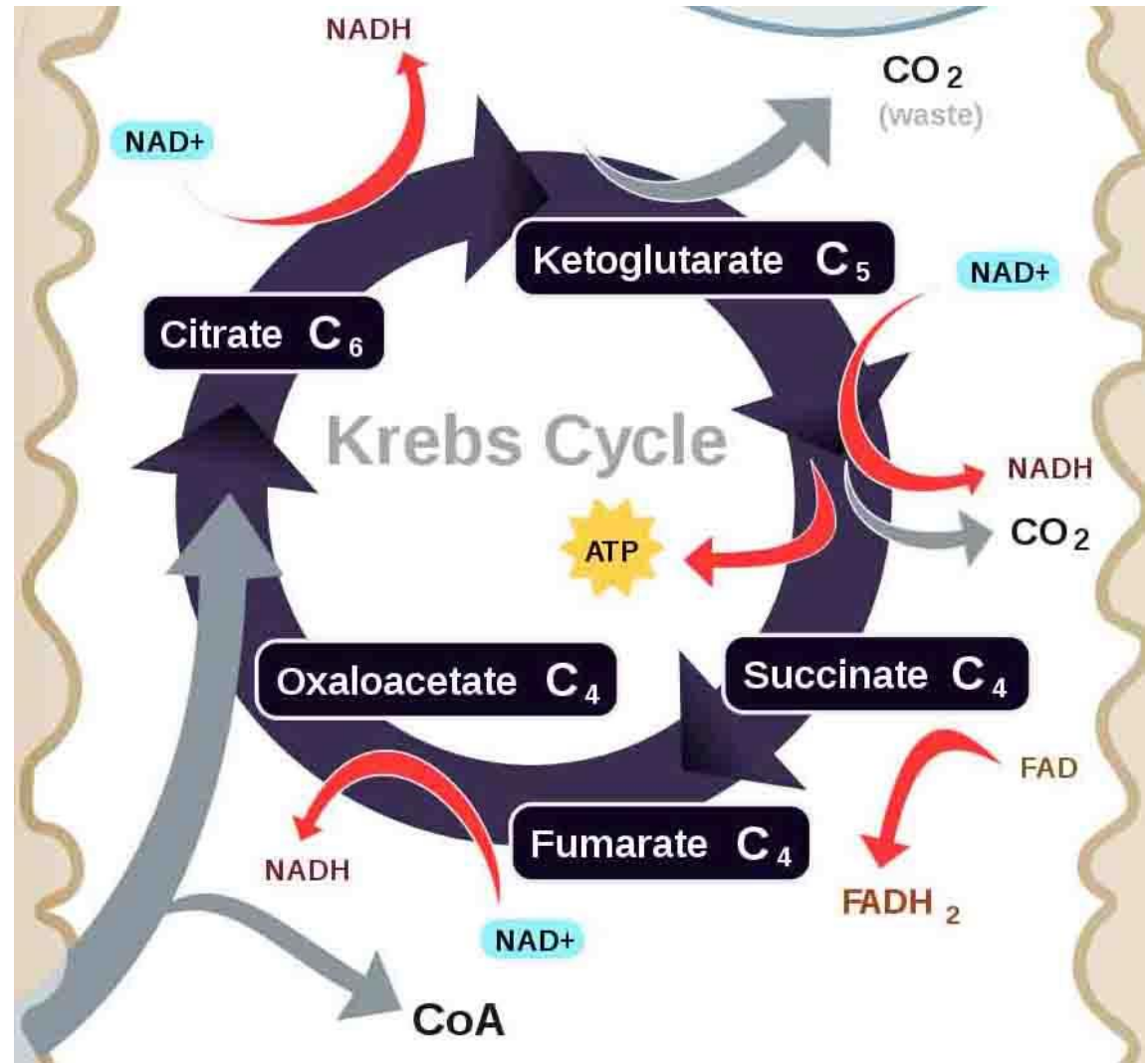

How do we metabolize fats?

REVIEW!

Simple animated graphic of Fat Catabolism

and

more in-depth animated lesson on Fatty acid Metabolism

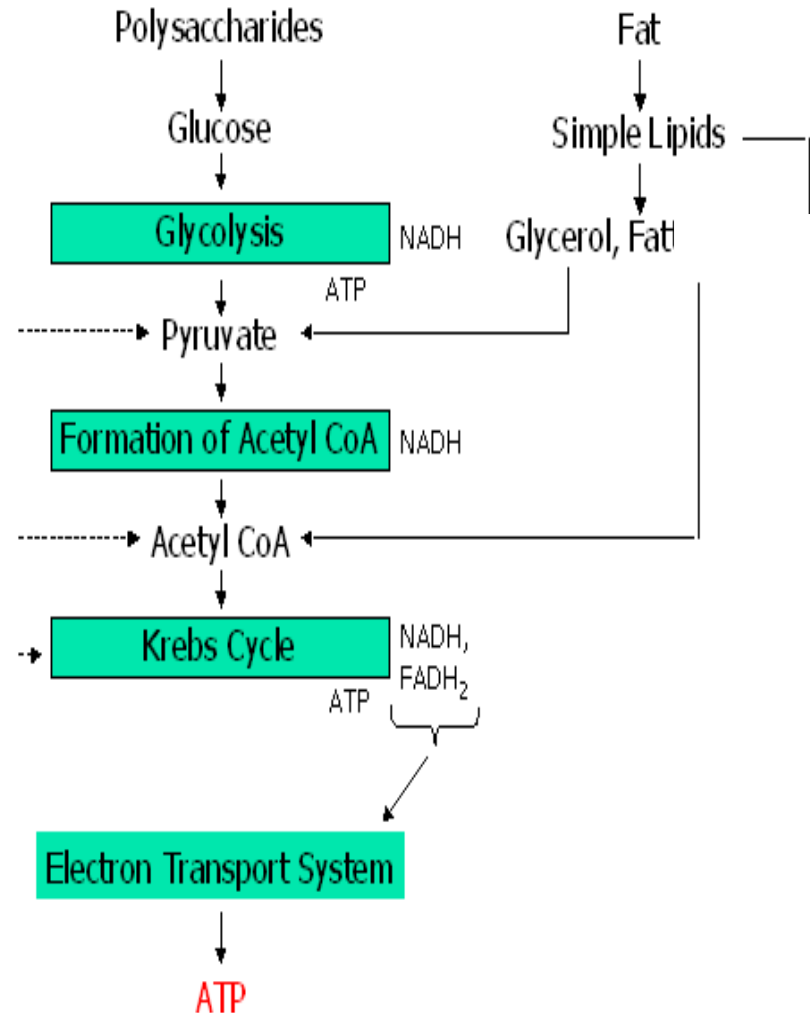

Metabolic Processes ... Bottom Line

Metabolism
transforms food
energy into energy
that our cells
can use.

Q: How does the cell
turn proteins
into ATP?

Q: How does the cell
turn fats
into ATP?



Confused?

Here are links to fun resources that further explain cellular respiration:

Smart Links



- [Metabolism of Proteins & Fats Main Page](#) on the Virtual Cell Biology Classroom of [Science Prof Online](#).
- [Cellular Respiration](#) animation by Jay Phelan, "What is Life? A Guide to Biology", W. H. Freeman & Co.
- ["Break It Down Again"](#) music video by Tears for Fears.
- [How NAD+ Works](#) animation and quiz from McGraw-Hill.
- [Glycolysis](#) animation and quiz from McGraw-Hill.
- [Kreb Cycle Animation & Quiz 1](#) from McGraw-Hill.
- [Kreb Cycle Animation & Quiz 2](#) from McGraw-Hill.
- [Electron Transport Chain](#) animation from Molecular & Cellular Biology Learning Center.
- [Food Molecules](#) video from HowStuffWorks, a Discovery company.
- ["The Protein Song"](#) ridiculous but funny song by RuanO
- ["Grease \(Is the Word\)"](#) sung by Frankie Valli.

(You must be in PPT slideshow view to click on links.)

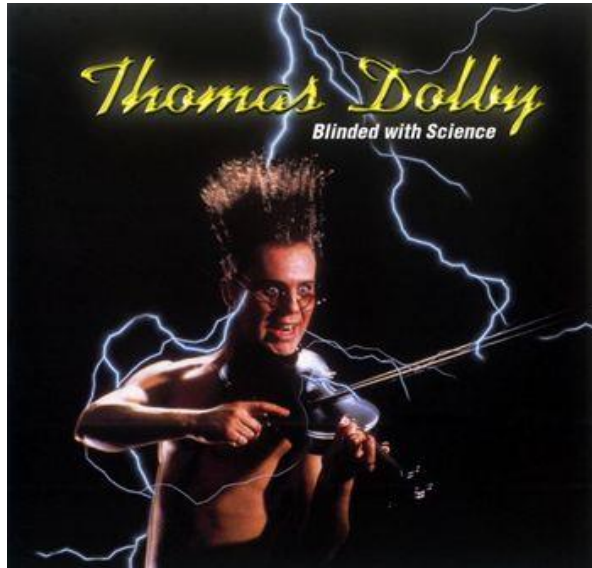

Are you feeling blinded by science?

Do yourself a favor. Use the...

Virtual Cell Biology Classroom (VCBC)!

The VCBC is full of resources to help you succeed,
including:



- practice test questions
- review questions
- study guides and learning objectives
- PowerPoints on other topics

You can access the VCBC by going to the Science Prof Online website
www.ScienceProfOnline.com